

--	--	--	--	--

Name

Present School

The London Independent Girls' Schools Consortium

Group 1

Mathematics Entrance Examination

15th January 2010

Time allowed: **1 hour 15 minutes**

Write in pencil.

Do all your rough working in the space near the question. Do not rub it out.

If you cannot answer a question go on to the next one.

CALCULATORS AND RULERS ARE NOT ALLOWED.

1.
$$\begin{array}{r} 4329 \\ + 7143 \\ \hline \\ \hline \end{array}$$

2.
$$\begin{array}{r} 3617 \\ - 908 \\ \hline \\ \hline \end{array}$$

3.
$$\begin{array}{r} 6253 \\ \times 7 \\ \hline \\ \hline \end{array}$$

4. $3216 \div 6 =$

Answer:

5. Put the following in order of size, starting with the smallest:

$$\frac{2}{5} \quad \frac{5}{8} \quad \frac{1}{2}$$

Answer:



6. Find $\frac{3}{8}$ of 48.

Answer:

7. Fill in the next number in these patterns:

5.5, 5.8, 6.1, 6.4, _____

3, 6, 12, 24, _____

8. Which of the following numbers is closest in value to 1 ?

1.1, 0.988, 1.009, 0.99, 1.01

Answer:

9. If two numbers multiply to give 36 and their difference is 5, what are the two numbers?

Answer:and.....



10. a. Choose from the signs +, -, x and ÷ to fill in the gaps.

$$9 \square 4 = 25 \square 5$$

$$8 \square 4 \square 3 = 7$$

b. Fill in the missing numbers:

(i) $32 \div (10 - \square) = 4$

(ii)

–	5	4	
	4	2	4
	1		6

11. Select 3 cards from the set below which show the same value.

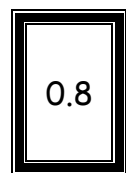
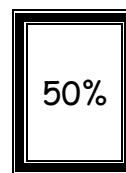
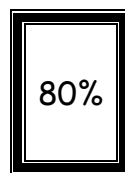
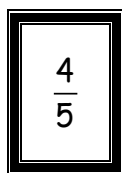
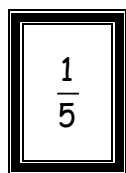
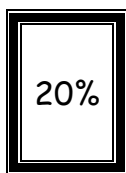

Answer:,,

12. Alisha wants to exchange the coins in her money box for £5 notes. She has

- Twelve 50p coins
- Eighteen 20p coins
- Seven 10p coins
- Twelve 2p coins

a. What is the greatest number of £5 notes she could receive?

Answer:

b. How much more money does she need to receive another £5 note?

Answer:

13. Tasha thinks of a number, multiplies it by 3 and then adds 8. Her answer is 35. What is the number she first thought of?

Answer:



14. Justin wants to make some bird tables to raise money for a charity.
To make **4 bird tables** he needs:

16 metres of wood
4 wooden trays
64 nails.

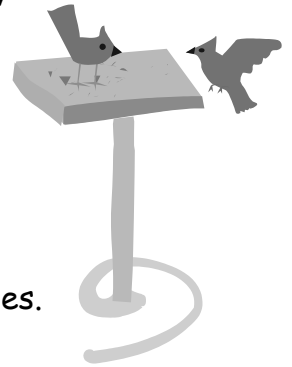

Write out the list of materials he would need to make **10** bird tables.

Answer: m of wood

Answer: wooden trays

Answer: nails

-
15. The Crystal Cinema shows the following prices for tickets and for popcorn.

Tickets
Adult £6.50
Child £3.00

Popcorn
Large £2.20
Small £1.50

Mr and Mrs Jenkins and their 2 children go to the cinema. Each child has a small bag of popcorn and the adults share a large bag of popcorn.
Mr Jenkins pays for the popcorn and the tickets with a £50 note.

- a. How much change does he receive?

Answer: £



Mr Jenkins parks his car at 14:30 and returns to the car at 16:25. He paid for 3 hours parking.

b. How much time does he have left on his parking ticket?

Answer:

16. Kristina and Ravi shared a box of sweets. Kristina ate $\frac{3}{5}$ of them.

If 12 sweets were left for Ravi, how many sweets were there in the box at the start?

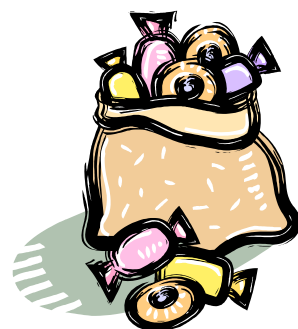

Answer:

17. Jessica was born on the 1st May 1992. She started to learn to play the piano on the 1st September 1998.

a. How old was she when she started to learn to play the piano? Give your answer in years and months.

Answer:yrs months

b. She was given a new piano on her 15th birthday. In which year was this?

Answer:



18.

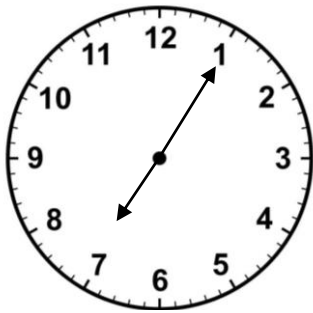

Clock A

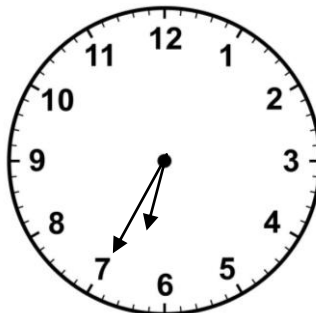

Clock B

Clock A is 12 minutes fast.

How many minutes slow is clock B?

Answer: mins

19. Nimita wants to hang some balloons for her birthday party. Each balloon needs 35cm of string attached to it.

a. What is the largest number of balloons she can hang with a 4 metre ball of string?



Answer:

b. What length of string would be left over? Give your answer in centimetres.

Answer: cm



20. Peter delivers newspapers on each of 6 days in a week. The deliveries take 55 minutes each day.

a. How many minutes does he take in total?



Answer:

b. He is paid £3.60 per hour. How much does he earn in one week?

Answer: £

21. Tick the box for the best estimate for these measurements:

a. The mass of a table-tennis ball 2.5g 30g 0.7kg

b. The amount of water in a full kettle 10l 2l 400ml

c. The diameter of a CD 120mm 50cm 50mm



22. a. What percentage of the circle is shaded?

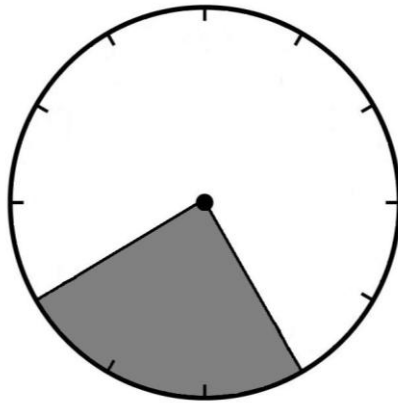

Answer:

b. What fraction of the shape is shaded?

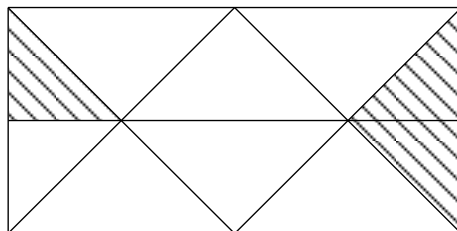

Answer:

c. Shade 25% of the shape.

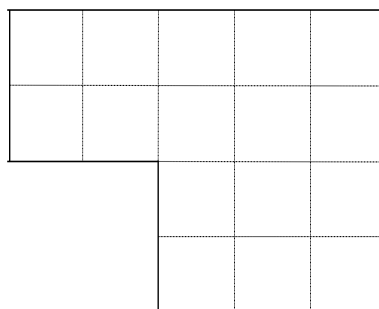

23. a. Which of these shapes has 2 lines of symmetry? Circle the letter.

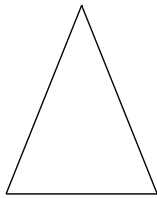

A

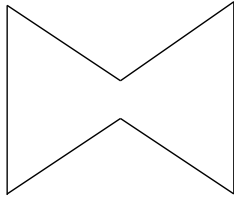

B



C

b. The diagram shows part of a shape which has the 2 lines of symmetry shown. Complete the shape.

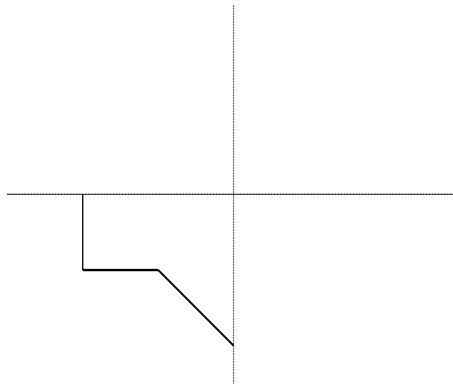

24. The pie chart represents 64 cars which passed a school in one hour.

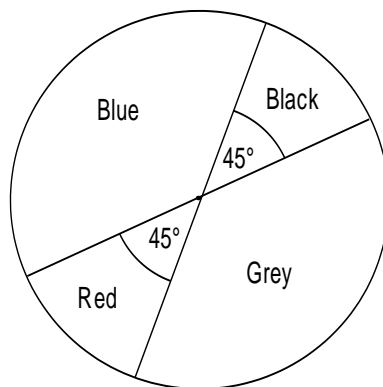

a. How many cars were red?

Answer:

b. What fraction of the cars were blue?

Answer:



25. A small **square** patio is built on a rectangular lawn.

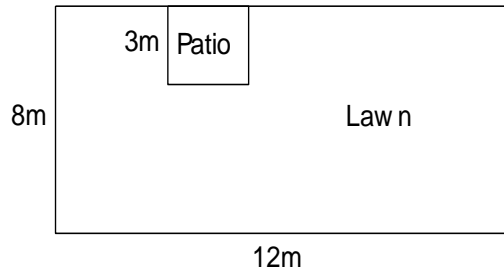

a. What is the remaining area of the lawn after the patio has been built?

Answer: m²

b. What is the perimeter of the lawn?

Answer: m

26. The diagrams are drawn in cm squares.

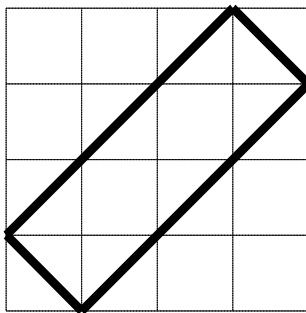

A

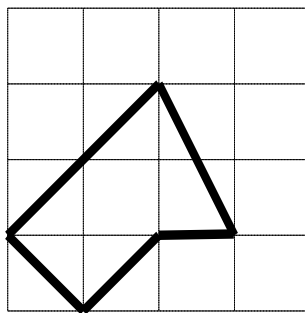

B

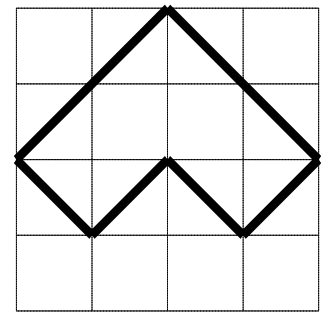

C

a. Which 2 shapes have the same perimeter?

Answer: and

b. What is the area of shape B?

Answer: cm²



27. Look at the scales:

a.

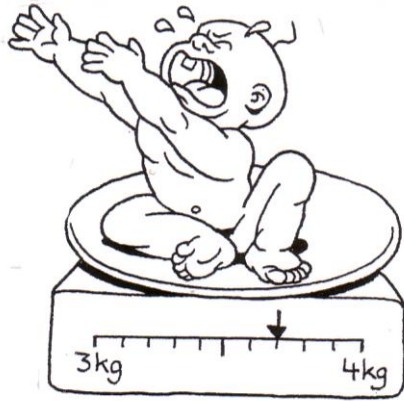

a. What does the baby weigh?

Answer:kg

b.

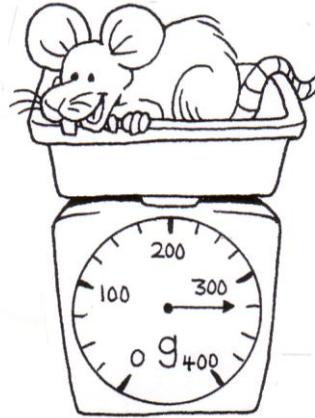

b. What does the mouse weigh?

Answer:g

c. The ruler below marks Anne's height. Fatima is 14cm taller than Anne. Show Fatima's height on the ruler in the same way.

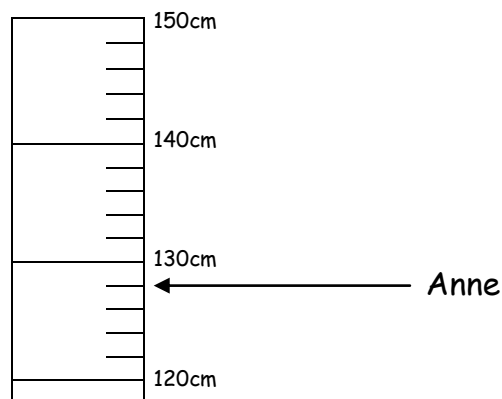

28. Sheri wants to fit the small shape into the rectangle without leaving any gaps.

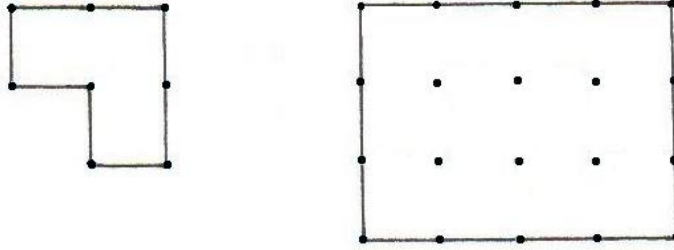

She uses exactly 4 of the small shapes as shown.

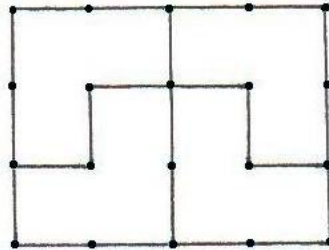

Show how she can fit exactly 4 of the small shapes into this shape without leaving any gaps.

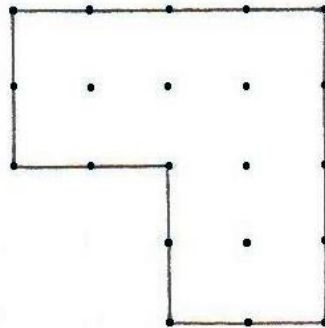

29. The shape is made from a square and an equilateral triangle.

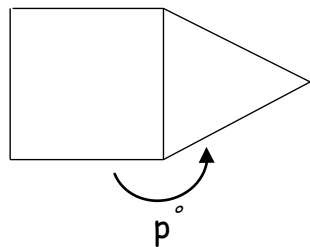

Diagram not drawn to scale.

What is the size of the reflex angle marked p° ?

Answer:



30. Small cubes like the one shown are put into the larger box.

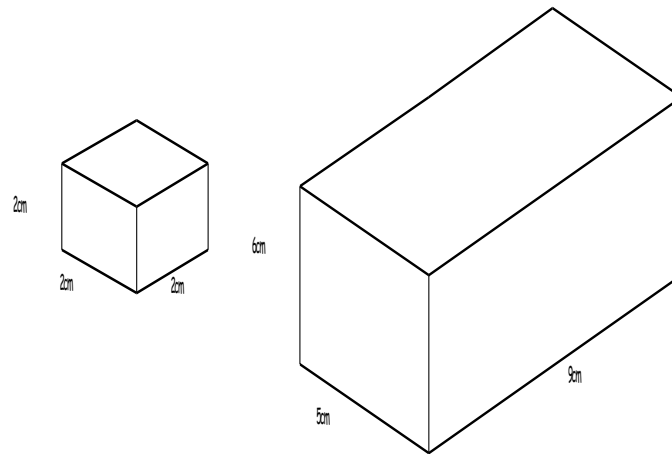

a. What is the largest number of small cubes which could fit into the bottom layer of the box?

Answer:

b. What is the greatest number of small cubes which could fit into the box?

Answer:



31. This solid is made of centimetre cubes.

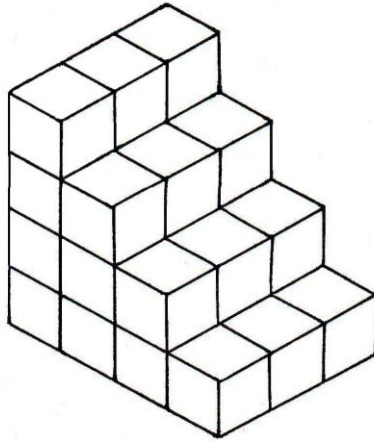

a. The solid is painted all over, including the base. What is the total area covered?

Answer:cm²

b. If it is taken apart and rebuilt into the cube below, how many centimetre cubes are left over?

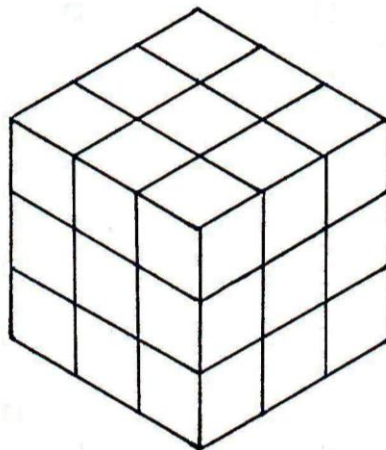

Answer:



32. This is a net of a cube.

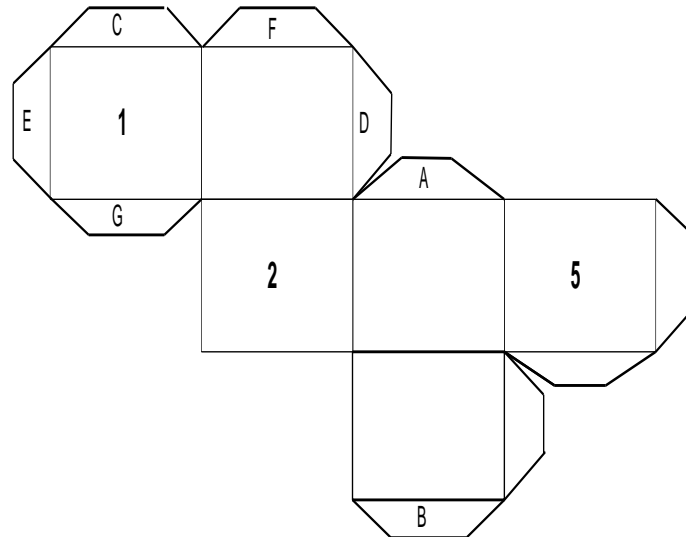

a. If the net is folded up to make the cube

i. Which tab connects to tab A?

Answer:

ii. Which tab connects to tab B?

Answer:

The numbers on opposite faces of the cube add up to 7.

b. Write the number 6 on the correct face on the diagram.



33. Given that $(21 \times 55) + 20 = 1175$, one of the following is incorrect.

Put a cross in the box next to it.

a. $1175 - 20 = 21 \times 55$

b. $21 \times (55 + 20) = 1175$

c. $1175 = 20 + (21 \times 55)$

d. $20 = 1175 - (21 \times 55)$

e. $(21 \times 55) + 21 = 1176$

34. A football competition was held between five Year 6 teams.
Each team played every other team once.
How many games did the teams play in total?



Answer:

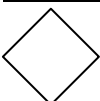

35. Mrs Fowler keeps chickens.

The table shows how many eggs her chickens laid on each weekday last week.

Day	Number of eggs
Monday	4
Tuesday	?
Wednesday	4
Thursday	3
Friday	11

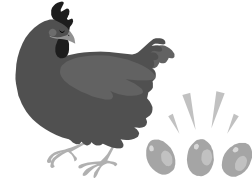

The mean number of eggs laid from Monday to Friday last week was 6.
How many eggs were laid on Tuesday?

Answer:

36. There are 30 children in Mrs Patel's Year 6 class.

- 8 of them are wearing glasses.
- 12 of them are wearing a watch.
- 7 of them are wearing both glasses and a watch.

How many are wearing neither glasses nor a watch?

Answer:

37. Sharpay is going shopping for some new stationery.
She can buy three pencils and a ruler for 50p or two pencils and two rulers for 56p.

How much does each pencil cost her?



Answer:p

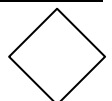

38. Zac has a set of 12 cards which are numbered from 1 to 12.
He turns them face down and picks **four** cards.

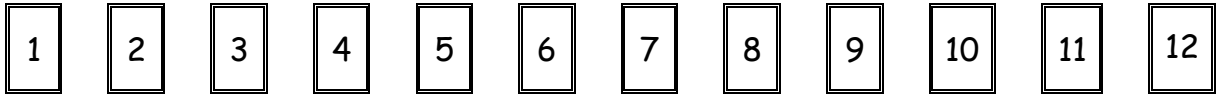

Exactly three of the four cards are **multiples of three**.
Exactly three of the four cards are **odd numbers**.
The total of the four cards is **less than 20**.

What must the four cards be?

Answer:,,,

39. Alice has saved £10 more than Becky.
Becky has saved £3 more than Charlie.
Altogether Alice, Becky and Charlie have saved £26.50.

How much has Alice saved?



Answer: £

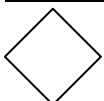

40. In 'star' arithmetic, $a*b$ means 'add a to b and then multiply the result by b '.

For example $2*3 = 15$.
and $3*4 = 28$.

a. Work out $5*6$

Answer:

b. Work out $\frac{1}{2}*\frac{1}{2}$

Answer:

c. Find a when $a*2 = 30$

Answer:

d. Find a when $a*a = 50$

Answer:

41. Ladybirds eat greenfly. On one bush, there are enough greenfly to feed 9 ladybirds for 4 hours.

a. How long would the greenfly last if there were only 6 ladybirds?

Answer:

b. How many bushes would be needed to feed 36 ladybirds for 2 hours?



Answer:

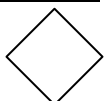

42. Factors are numbers that divide into another number exactly.
For example, the factors of 28 are 1, 2, 4, 7, 14 and 28.

28 is called a **perfect number** because the factors of 28, not including the number 28 itself, add up to 28.

So, $1 + 2 + 4 + 7 + 14 = 28$.

a. i. Find all the factors of 12, not including 12.

Answer:

ii. Is 12 a perfect number?

Answer:

b. There is a perfect number less than 10. What is it?

Answer:

c. 496 is another perfect number.

496 has ten factors.

Two of them are 1 and 496.

List the others.

Answer:

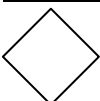

43. Glen is older than Florence.
Ahmed is older than Zara but younger than Florence.
Oliver is younger than Glen but older than Zara.
Yasmin is younger than Glen.
Ahmed is older than Oliver.
Florence is younger than Yasmin.

Which of these six friends is the youngest?

Answer:

44. In a magic square, the total for each row, column and diagonal is the same.

The diagram below shows part of a magic square.

	4	17
		m
5		

What is the value of m?

Answer:

End of Paper

